



Electric Service Bulletin No. 759A – January 2024

Supplement to
**Specifications for
Electrical Installations**
Underground Residential Distribution (URD)
Installation and Responsibility Guide



Table of Contents

URD Specifications and Installation Guide Acknowledgement (Job Spec/Signoff Forms)	1
URD Specifications and Installation Guide Acknowledgement (Job Spec/Signoff Forms)	3
1.0 Scope	5
2.0 General Requirements	5
3.0 Type of Service	6
4.0 Plans	6
5.0 Permits	6
6.0 Division of Responsibility	7
7.0 Easements	9
8.0 Trench Construction Requirements	9
9.0 Trench and Conduit System Inspection	10
10.0 Conduit Installation.....	11
11.0 Transformer Box Pad Installation.....	12
12.0 Transformer Secondary	12
13.0 Transformer Grounding and Bonding	13
14.0 Spacing of Boxpads, Pullboxes, and Handholes	13
15.0 Proper Transformer Pad and Conduit Layout.....	14
Figure 15.0-1 Preferred Location of Equipment in Easement Area	14
Figure 15.0-2 Single Phase Padmount Transformer — Typical Layout.....	15
15.0-3 Single Phase Padmount Transformer — Direct Burial Layout.....	15
16.0 Transformer Ground Grid Bonding	16
Figure 16.0-1 Single Phase Padmount Transformer Ground Grid.....	16
Figure 16.0-2 Single Phase Padmount Transformer Ground Grid — Front Elevation.....	17
17.0 Proper Transformer Pad and Conduit Installations.....	18
17.0-1 Proper Conduit Bank Installation (Pre-Backfill).....	18
17.0-2 Proper Installation of Conduit with Pullbox used for Drainage (Pre-backfil)	18
17.0-3 Proper Conduit and Handhole Installation (Pre-backfil).....	18
17.0-4 Properly Completed Transformer Installation (Final Grade)	19
17.0-5 Properly Completed Handhole Installations (Final Grade).....	20
18.0 Transformer Oil Containment.....	22
Figure 18.0-1 Single Phase Oil Containment for Cables in Conduit	22
Figure 19.0-2 Single Phase Oil Containment for Direct Buried Cables	23
19.0 Riser Pole.....	25
20.0 Primary Cable Pull/Splice Box	27
21.0 Trench Requirements.....	29
Figure 21.0-1 Typical Trenches.....	30
22.0 Conduit Requirements	30

22.1 Pulling Tape	30
22.3 Communication Systems	31
22.4 Non-Company Water, Gas and Sewer	31
23.0 Metering	31
24.0 Sectionalizing Cabinets - Three Phase and Single Phase Applications	32
25.0 Easement Applications.....	32
26.0 Approved Material – Underground Residential Installations.....	35
27.0 Job Checklists	38
28.0 Revision History	39

URD Specifications and Installation Guide Acknowledgement (Job Spec/Signoff Forms)

The requirements and specifications outlined in this guidebook must be strictly followed. Any requirements not adhered to can pose safety problems, can be detrimental to the installed system and must be corrected before final acceptance. The *Customer* will bear full cost to make corrections to sub-standard installations.

The *Customer* is responsible to provide enough lead time for the *Company* to design job, provide inspections and install *Company* equipment where applicable.

Typical lead times are shown below.

	Lead-Time	Notes
Design and Layout	Eight weeks	Company receives all required plans, load data and easement information
Trench, Conduit and Equipment Inspection	Three days	Company inspector
Company Installation	Four weeks	After all inspections are approved and permits/easements are procured
Material Pick up (if required)	10 Days	Company inspector
<i>NOTE: The above times are estimates only.</i>		

Project Title _____

Location _____

Owner/Developer _____

Customer's Representative _____ Date _____

Company Representative _____ Date _____

Company's Copy

URD Specifications and Installation Guide Acknowledgement (Job Spec/Signoff Forms)

The requirements and specifications outlined in this guidebook must be strictly followed. Any requirements not adhered to can pose safety problems, can be detrimental to the installed system and must be corrected before final acceptance. The *Customer* will bear full cost to make corrections to sub-standard installations.

The *Customer* is responsible to provide enough lead time for the *Company* to design job, provide inspections and install *Company* equipment where applicable.

Typical lead times are shown below.

	Lead-Time	Notes
Design and Layout	Eight weeks	Company receives all required plans, load data and easement information
Trench, Conduit and Equipment Inspection	Three days	Company inspector
Company Installation	Four weeks	After all inspections are approved and permits/easements are procured
Material Pick up (if required)	10 Days	Company inspector
<i>NOTE: The above times are estimates only.</i>		

Project Title _____

Location _____

Owner/Developer _____

Customer's Representative _____ Date _____

Company Representative _____ Date _____

Customer's Copy

1.0 Scope

The purpose of this specification is to define, interpret and clarify the scope of work and material dealing with providing service to URD's and is a Supplement to Electrical System Bulletin (ESB) 750.

It is important that the Specifications for Electrical Installations book (ESB 750) be obtained and referred to in conjunction with this supplement for these installations. Any reference to the *Company* in this specification shall mean the Liberty Utilities. Any reference to the *Customer* or *Developer* in this specification shall mean the property owner or the designee of the property owner of the URD.

2.0 General Requirements

All electrical wiring to be connected to the *Company* equipment shall be installed in accordance with one or all of the following:

- ▶ Local Municipal Inspection Authority
- ▶ State's Electrical Code
- ▶ National Electrical Code
- ▶ National Electrical Safety Code
- ▶ Applicable Distribution Construction Standards of the *Company*
- ▶ Liberty Utilities' Specifications for Electrical Installations

There shall be no attempt to deviate from either the Distribution Standards of the *Company* or the *Company* construction plan without the approval of the *Company*. Any specifications noted shall supersede the Specifications for Electrical Installations booklet unless otherwise approved by the *Company*.

It is mandatory that the *Customer* and all parties involved attend a documented pre-construction meeting with a *Company* representative to discuss the project and ensure it a timely completion. A *Company* representative will make the necessary arrangements for the pre-construction meeting. *Company* representatives will also be available throughout the job life cycle to discuss construction problems when requested or during a field visit.

References:

- ▶ ESB 750 - Specifications for Electrical Installations
- ▶ ESB 759B – UCD Installation and Responsibility Guide
- ▶ ESB 759C – Residential Underground Services

All ESB's are available at

<http://new-hampshire.libertyutilities.com/allentown/commercial/electricity-partners.html>

The Customer shall be responsible to have all electrical and physical design documents prepared and updated by a design professional, in accordance with Section 1.7 of ESB 750 for the trenching, conduit, transformer pad, and handhole installations.

3.0 Type of Service

Electric service shall be single phase, three wire, 120/240V supplied from a padmount transformer or handhole to be located on the *Customer's* premises. On January 1, 2019, the *Company* will install, own and maintain residential underground secondary services. The *Customer* is responsible for the installation of the conduit to the house from the designated transformer or handhole. The primary electrical service to the URD will be supplied from a pole or cable system owned by the *Company*.

4.0 Plans and Other Documents

The total number of house lots proposed to be constructed will be provided in advance to the *Company* by the *Customer*, along with a complete copy of the subdivision plans approved by the planning board in the municipality, if such is required by the municipality. The *Company* will not begin design work prior to receipt of the approved plans.

The *Company* may require the *Customer* to provide, in advance and at no cost to the *Company*, the following:

- i. A copy of the approval of the planning board for the subdivision.
- ii. Copy of all permits and approvals that have been obtained for constructing the development.
- iii. Easements, drafted by the *Company*, for all facilities required to serve the development.
- iv. The name and address of the financial institution providing financing for the development, including a contact person and phone number.
- v. A copy of a street light proposal for the development, approved by the municipality, or written notice from the municipality that street lighting will not be required; if installation is requested after construction is complete, additional costs, may be borne by the municipality and/or *Customer* if the tariff does not collect all costs of construction.
- vi. A schedule of *Customer's* best estimate for the construction of homes in the development; and
- vii. Such other reasonable information that may be requested to confirm the viability of the development.

Conduit Systems in general: will be designed to support a looped primary system with no spare conduit. The *Company* requires a spare conduit for all *Company* owned radial duct systems, as shown in *Company* plans. Other utilities must maintain clearances as outlined in the NESC.

5.0 Permits

In general, all applicable permits necessary to trench and excavate, including street openings and environmental permits, shall be obtained by the *Customer* and made available upon request of *Company* prior to design. The *Customer* shall be responsible for including these padmount and conduit/trench specifications with the wetlands application for developments located in or near wetlands. A copy of the wetlands permit may be requested by the *Company* prior to acceptance of the conduit/trench system by the *Company*.

The *Customer/Company* doing the excavation shall obtain the required **DigSafe®** permits before any excavation may take place in a public way. The *Customer/Company* doing the excavation is urged to obtain copies of the applicable statute and become familiar with its requirements. Similarly, the *Customer/Company* shall determine if the municipality in which the excavation is to be done requires that water, sewer, or other utility, municipal or private, be contacted separately due to the possibility they may not be members of **DigSafe®**.

The *Customer* is also responsible to notify the company of all as built changes that may conflict with design).

The *Customer* shall certify to the *Company* that areas in which the *Company* is to perform installation or maintenance work is free of pre-existing contamination by hazardous wastes or materials and to indemnify the *Company* for any claims, costs, expensed, suits, demands, citations, fines or damages of any kind arising from the presence of any such contamination.

The Company may, at its discretion, construct the underground distribution line in segments, rather than all at once in the proposed development. The Company may, at its option, be exempt from undertaking construction during the period of December 1 to April 1 each year.

6.0 Responsibility and Ownership

The division of ownership and responsibility shall be as outlined below, as specified by the State of New Hampshire PUC Tariff for Retail Delivery Service. Typical installation specifications to reflect installation practices are shown in the back of this guide.

6.0.1 New Underground Residential Development (URD)

The Company shall be responsible for:

- Develop the plan to provide underground electric service for the development,
- Designating riser pole location or underground switching cubicle for primary service
- Supply a list of approved manufacturers and their part numbers for equipment to be supplied by the customer, (See Pages 35 – 37)
- Designate the location of all *Company* owned equipment,
- Provide, install, own, and maintain all transformers, *Company* owned streetlights, primary and secondary cable, except services,
- Make all connections to *Company* equipment,
- Inspecting transformer foundation boxpad installation (including ground grid), other designated *Company* owned equipment installations, conduit system, and trenching to provided *Company* specifications, installed by *Customer* and prior to backfilling.
- Determine if oil containment shall be required for padmount transformer installation.
- Install, own, and maintain all secondary service cables from the *Company's* equipment to each *Company's* designated meter location.

The Customer, at no cost to Company, shall be responsible for:

- Contacting Liberty Utilities to request for a new electric service for an Underground Residential Development and obtain a work request number. This should be one of the first actions in the process to provide for applicable planning, material order, and construction schedule.
- Provide, prior to the start of the *Company's* construction, all applicable documents required for the *Company* to prepare easements and design for its facilities to be installed on private property.
- Provide and install foundations and conduit for *Company* owned streetlights, to provided *Company* specifications and in which locations have been approved by the local municipality.
- Provide and install all required handholes, foundation boxpads, pull/splice boxes, grounding systems, and conduit including spacers, galvanized conduit and sweeps for riser poles including bonding clamps and neutral tap, glue and pulling tape, etc. as indicated on the *Company's* plan and related construction specifications,

- Supply copies of all invoices, when requested, indicating manufacturer and part number for all such equipment above; equipment that is not approved shall not be used without the prior written consent of the *Company*,
- Turn over ownership of the conduit system, excluding the service conduit, to the *Company* upon inspection and acceptance of the conduit system by the *Company*,
- Provide and install material for oil containment under padmounted transformers where required.

6.0.2 New Underground Single Phase Primary Radial Service Located on Private Property to an Individual Residential Customer

The *Company* will provide a Single Phase Primary Radial Service to a *Residential Customer* from the *Company's* distribution system under the conditions shown below.

The *Company* shall be responsible for:

- Developing the plan to provide underground electric service (if feasible);
- Designating the location of all *Company* owned equipment, the service entrance, and meter location.
- Designating riser pole location or underground switching cubicle for primary service.
- Designating pad mount transformer location with protection (bollards), if required, and if oil containment is required for transformer foundation boxpad.
- Inspecting transformer foundation boxpad installation (including ground grid), other designated *Company* owned equipment installations, conduit system, and trenching to provided *Company* specifications.
- Installing, owning, and maintaining:
 - Single Phase Pad Mount Transformer, primary cable and cable terminations, secondary cable, and meter (up to and including 400 Amp service).

The *Customer*, at no cost to *Company*, shall be responsible for:

- Contacting Liberty Utilities to apply for a new electric service and obtain a work request number. This should be one of the first actions in the process to provide for applicable planning, material order, and construction schedule.
- Obtaining any required municipal electrical permits and arranging electrical inspection.
- Providing, prior to the start of the *Company's* construction, all applicable documents required for the *Company* to prepare easements for its facilities to be installed on private property.
- Providing, prior to the start of the *Company's* construction, a signed easement, drafted by the *Company*, for *Company* owned equipment on private property.
- Provide and install all required handholes, foundation boxpads, pull/splice boxes, grounding systems, and conduit including spacers, galvanized conduit and sweeps for riser poles including bonding clamps and neutral tap, glue and pulling tape, etc. as indicated on the *Company's* plan and related construction specifications,
- Installing a primary riser (conduit system), 8 feet above ground shall be galvanized steel, including 90-degree steel sweep flush mount to pole designated by the *Company*, and bonding clamp with copper wire tap for grounding. The *Company* will install ground rod and complete bonding requirements.
- Providing and installing *Company* approved Self-contained Meter Socket at location **Pre-Approved By the Liberty Utilities Meter Department.** Refer to Liberty Utilities ESB # 750 Specifications for Electrical Installations, latest version, Section 7.0 Metering, for Self-contained Meter Socket requirements.

7.0 Easements

In general, *Company*-owned equipment shall not be installed on the *Customer's* property prior to the execution of suitable easement(s). The *Customer* will have to provide to the *Company* (for the purposes of securing an easement) the following items, including but not limited to:

- ▶ Copy of property deed showing owner, date, book number, page number county registry, and survey and/or plan of record, if available.

Note: When electronic maps are used, the Customer must consult the Company for submittal.

- ▶ Copy of mortgages showing holder, date, book number, page number and county registry.
- ▶ Copy of any applicable trusts showing date, book number, page number and county registry, and who is authorized to sign legal documents on behalf of the Trust.

Easement application forms are located on Page 33. Refer to Sections 3.1.3 and 4.1.1 in ESB 750 for further easement requirements applicable to the Applicant or Customer.

8.0 Trench Construction Requirements

- a. Layout and Grading
 - i. Final grades shall be established, and the binder coat installed, and easement boundaries, street, lot and trench lines staked by the *Customer* before any trenching is started (except for *Company* inspected road crossings).
- b. Trenching and Backfilling
 - i. The Customer shall adhere to the construction plan specifying trench locations and depths, with any deviation being subject to approval by the *Company*.
 - ii. Minimum burial depths specified for all electrical conduit and direct burial trenches shall be maintained during all phases of construction. Temporary mechanical protection over buried conduit during construction to prevent conduit crushing or damage due to unusually heavy construction equipment shall be the responsibility of the *Customer*.
 - iii. Trench detail shown in attached *Company* Standards shall be adhered to. The trench bottom shall be solid, undisturbed earth. Earth showing signs of peat, cinders, rubble, or any conditions not suitable for a stable foundation shall be reported to the *Company* Representative for recommendation. Pockets of unsuitable soil shall be replaced with compacted sand.
 - iv. For work done by *Customer*, a *Company* representative shall be notified in advance of the backfilling of any electric facility, i.e., conduit, foundation, handhold, pull-box, cable-in-conduit, grounding, cables, etc.

If any facility is backfilled without the *Company's* prior approval, the *Company* reserves the right to require re-excavation of the facility.

- aa. Sand for conduit installation - A minimum of three inches of sand shall be placed, under, beside, around and on top of all electric conduits. The sand shall pass through 3/8-inch mesh screen and shall not contain any sharp stones. Sand shall be placed and suitably tamped over installed conduit in reasonably small quantities (not a front-end loader bucketful all at once) to avoid conduit damage. Sand shall be evenly distributed between and around all electric conduits.
- v. Remainder of backfill shall not contain stones greater than one inch and shall not contain ashes, cinders, shell, or frozen material,
- vi. Trenches shall be immediately backfilled following cable or conduit system inspection and approval by authorized Company representative,
- vii. Backfilling shall be accomplished in a continuous manner from one terminal, i.e., riser pole, foundation, handhold, etc. to the next,
- viii. Backfilling shall not take place over any open-ended (unplugged) conduits,
- ix. Company approved red cable "Warning" or "Marking" tape shall be installed in the trench 12 inches below finished grade and directly above the cable or conduit.

9.0 Trench and Conduit System Inspection

In the applicable area, a designated *Company* inspector shall be responsible for the inspection of the trench and/or conduit system being prepared and installed by the *Customer* at various stages of installation. The *Customer* shall provide the *Company* inspector with a minimum of 24 to 72 hours' notice.

Inspections shall be conducted:

- 1) After conduit and ground system are completed; but before concrete is poured
- 2) After concrete is poured, but before backfilling if applicable
- 3) After backfilling

The inspection shall include, but not be limited to the following:

- ▶ All trenches and excavations
- ▶ All material supplied by the *Customer*.
- ▶ All backfill and base sand material during or after installation as applicable.
- ▶ All foundations, pull-boxes, boxpads, handholes, ground grid, and other facilities, after setting in place, but prior to backfilling.
- ▶ All galvanized steel riser pole and sweep conduit installations, all conduit, including cemented joint, bends, sweeps, bell-ends, and conduit spacers, prior to backfilling, or concrete encasement.
- ▶ All conduit terminations and supports at boxpads, pull-boxes, handholes, riser poles, streetlight foundations, and at other applicable locations.

- ▶ The pouring of any required concrete encasement and subsequent backfilling around the conduit runs.
- ▶ All backfilling operations
- ▶ Witnessing mandrelling of all conduits

10.0 Conduit Installation

- a. Conduit shall be installed, by *Customer*, in accordance with the *Company* Standards and Construction Plans which accompany this specification package.
- b. Plastic spacers shall be used to separate all ducts where more than one duct is installed. Spacers shall not exceed eight foot intervals. Spacers shall be placed at each coupling. Spacers are required to maintain proper separation from adjacent conduits and to aid in proper sand placement for thermal reasons.
- c. Type PVC DB-60 conduit (PVC Schedule 40 as alternative) shall be employed whether duct is direct buried or encased in concrete.
- d. All galvanized steel sweeps at risers shall have a minimum radius of 36 inches. 48-inch radius sweeps are required at transformer foundations and secondary handholes. See Page 13 for details.
- e. Curves and bends in conduit runs shall be gradual, and the radius of curvature shall not be less than 40 feet. Only five Degree Angled Couplings shall be used to make these gradual bends.
- f. Conduit grade shall be such as to cause all ducts to drain toward one or both equipment foundations, primary pull/splice boxes or handholes. Minimum pitch shall be three inches per 100 feet. Pull/splice boxes may be required near riser pole if grade at pole is low compared to the first boxpad to alleviate water buildup in risers.
- g. Conduit shall have a maximum penetration inside walls of primary pull/splice boxes, equipment foundations or handholes of three inches. All unused conduits and conduit knockouts shall be sealed with conduit plugs. Bell ends shall be installed at the end of all conduit runs.
- h. The minimum separation between electrical conduit and foreign conduit or pipes shall be as follows:
 - ▶ Communication systems – 12 inches
 - ▶ Water, Gas and Sewer – 12 inches where the paths of these utilities intersect electrical conduits at approximately right angles. A minimum separation of 24 inches shall be maintained between parallel placement of any of these utilities and electrical conduits.
- i. All road crossings shall, when practical, be perpendicular to the sidelines of the road.
- j. All road crossings shall have 30-inch minimum burial depth, top of conduit to finished grade, for primary and 24 inch minimum for secondary voltages. (Including street lighting cable-in-conduit) Main electric trench shall maintain conduit depths as shown in on Page 29. A primary burial depth could be lessened to 24 inch minimum where supplemental

protection is provided (i.e., concrete or steel barrier). Approval of *Company* representative is required.

k. Where foreign objects threaten to interfere with the installation of conduit in the sidewalk area or other areas, the *Company* may require concrete encasement of the conduit.

11.0 Transformer Box Pad Installation

- ▶ All foundations shall be level and installed in accordance with drawing on Pages 12-13.
- ▶ A minimum of four inches base course of crushed stone (3/4 in maximum stone size) shall be placed under all transformer foundation excavations and thoroughly compacted using a vibratory compactor. Certain soil conditions may require removal below normal depth and subsequent additional clean sand, or stone added and compacted to insure sound base course for foundation. For direct burial cable installation, cables are to be surrounded by at least 4" of sand at base area crossing from the trench into the box pad.
- ▶ Transformer foundation top surfaces shall be four inches above final grade. In no instance shall final grades hamper proper access or operation of equipment.
- ▶ A buried ground grid shall be installed in accordance with details shown on Pages 16 and 17. Ground loop around transformer to be buried 12" below finish grade (not at foundation base depth). Telephone *Company* bond wires shall be tied to the ground grid. Such bonding or connection shall not interfere with connecting *Company* equipment.
- ▶ Retaining walls or other devices shall be installed where slopes exist that would undermine or cover equipment, such as transformers due to sharp drop-off or rise.
- ▶ Upon completing the installation of the transformer foundation, the top opening shall be securely sealed with a suitable matching cover.

NOTE: In most instances, the Company shall require that equipment easements on private property be reasonably level. Also, all retaining walls shall fall outside of equipment easements and in no case shall they hamper door openings or placement of such equipment. Retaining wall design shall be approved by the Company.

- ▶ Transformer foundation shall be completely backfilled prior to commencing any cable pulling.
- ▶ In some locations oil containment may be required for box pad installation, Pages 22 and 23 show installation procedure.

12.0 Transformer or Handhole Secondary Service

As of January 1, 2019, the *Company* will install, own, and maintain residential underground secondary services. The *Customer* is responsible for the installation of the conduit to the house from the designated transformer or handhole. Refer to the latest version of Liberty Utilities ESB No. 759C Residential Underground Services for Electric underground residential service installation requirements.

13.0 Transformer Grounding and Bonding

The ground grid shall be #2, bare, soft drawn, 7 strand copper wire. The wire shall be installed 12 inches below finished grade and located around the transformer pad as shown on Page 16. Bond to all exposed metallic conduit and leave three feet of wire above pad for grounding transformer.

Two 5/8 inch diameter, eight feet long copper weld ground rods and approved connectors shall be installed to 12" below finished grade. Leave the ground rods and grid exposed until inspected by the *Company*. The ground grid is to be complete and backfilled prior to energizing the transformer. Connections to ground grid to be made with compression connectors as shown on Pages 14 and 15. However exothermic welding ("cad weld") shall be an acceptable alternative to a compression connection. Bolted connectors are only acceptable for the ground grid connections to the ground rods. The *Company* shall install the ground taps onto the transformer.

14.0 Spacing of Boxpads, Pull/Splice boxes, and Handholes

All communication boxes shall be a minimum of 2' away from any *Company* boxpad, pullbox or handhole. Also, communication equipment shall not be placed in front of any *Company* equipment.

15.0 Proper Transformer Pad and Conduit Layout

Figure 15.0-1 Preferred Location of Equipment in Easement Area

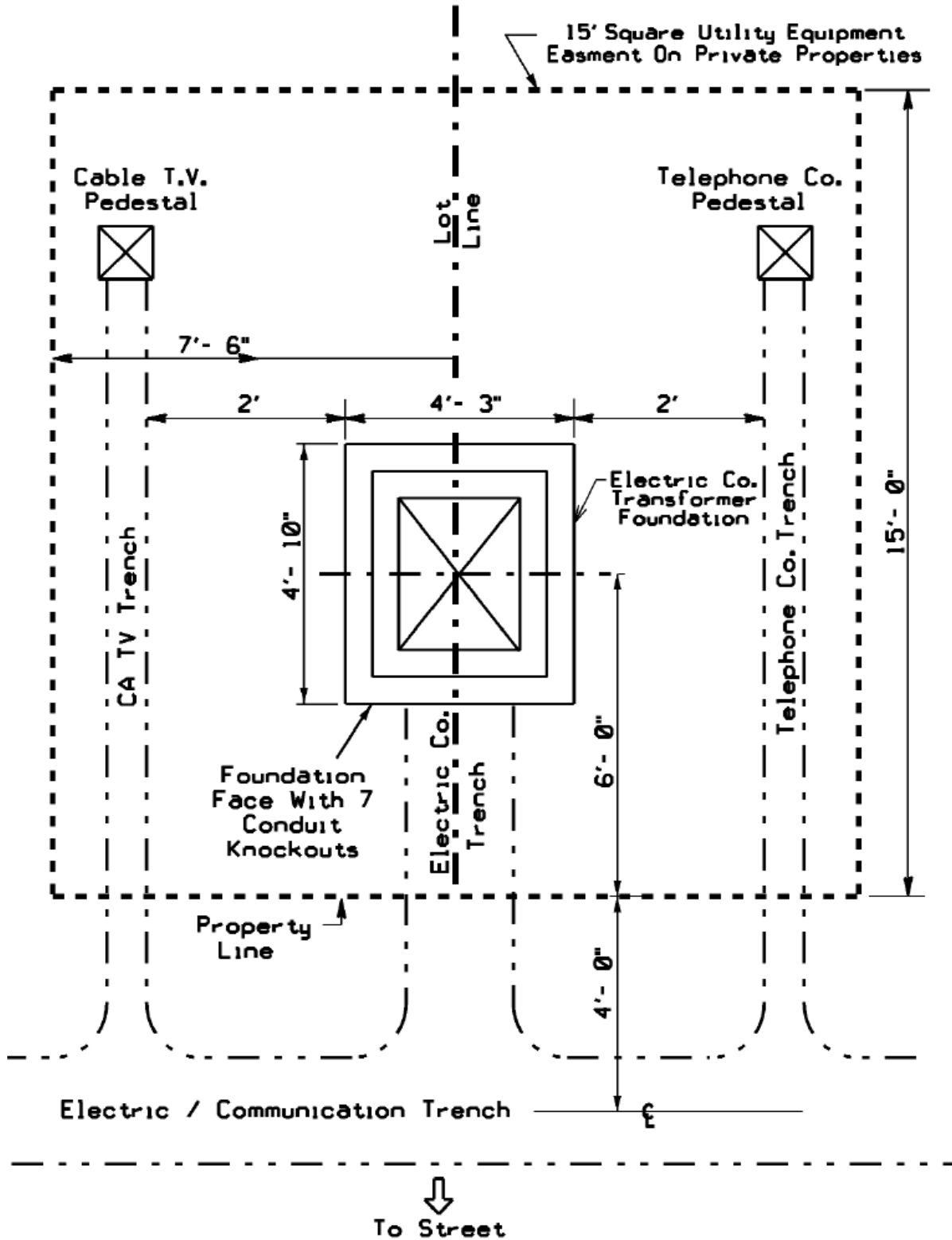
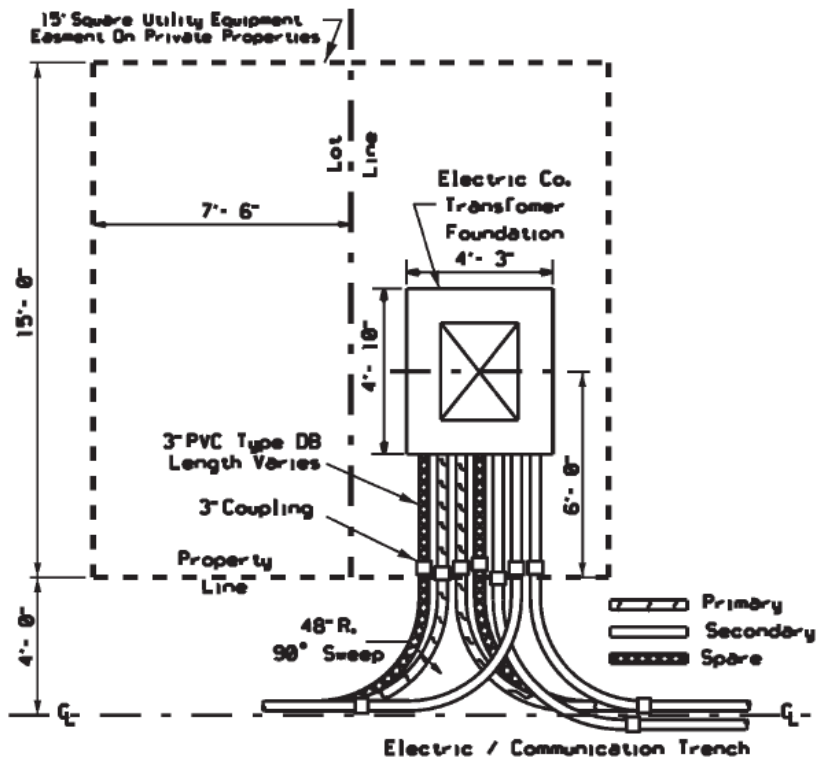
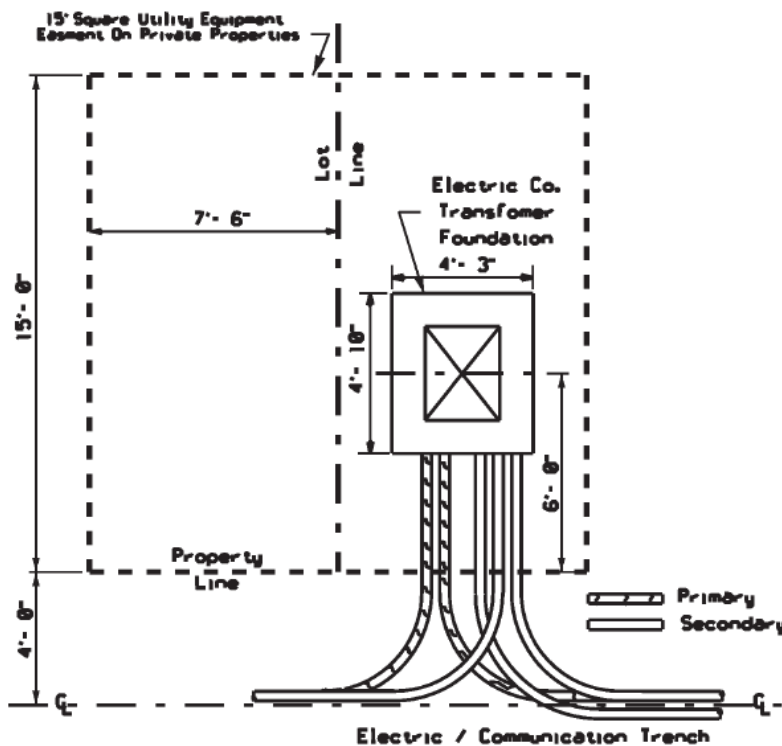

Figure 15.0-2 Single Phase Padmount Transformer — Typical Layout



15.0-3 Single Phase Padmount Transformer — Direct Burial Layout



16.0 Transformer Ground Grid Bonding

Figure 16.0-1 Single Phase Padmount Transformer Ground Grid

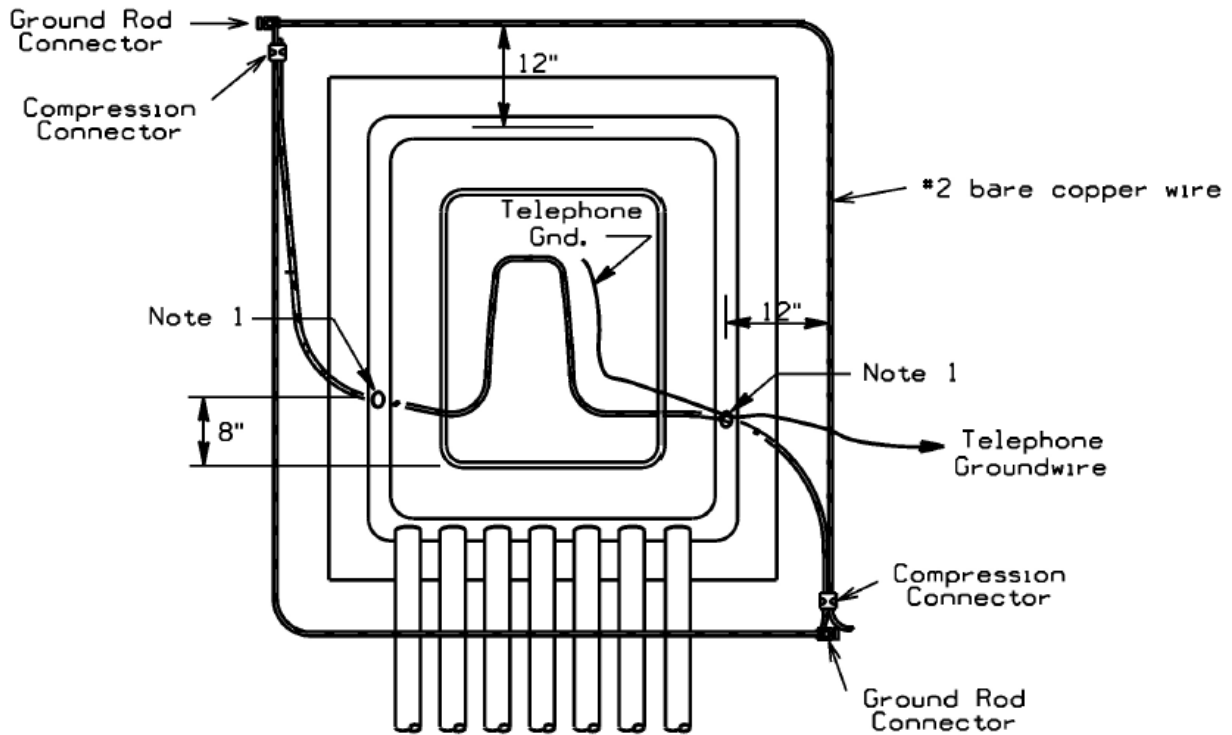

Notes:

1. The ground grid shall be #2, bare soft drawn, 7 strand copper wire. Installed 12 inches below finished grade and located around the foundation used for cabinets. Drill 5/8 inch diameter holes as shown in sides of foundation if not provided by foundation manufacturer.
2. Two 5/8 inch diameter, eight foot long copperweld ground rods and approved connectors shall be installed 12 inches below finished grade.
3. Leave the ground rods and ground grid exposed until inspected and approved by the *Company* representative.
4. The ground grid is to be complete and backfilled prior to energizing the equipment.

Figure 16.0-2 Single Phase Padmount Transformer Ground Grid — Front Elevation

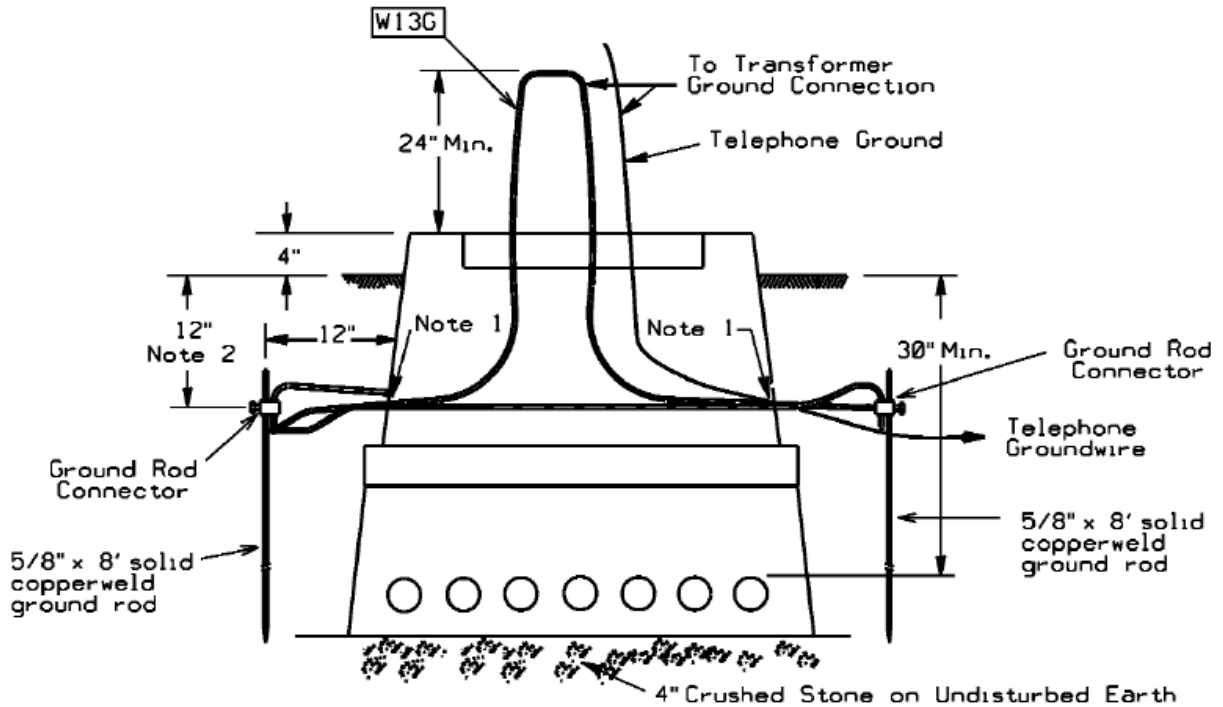
**Notes:**

1. The ground grid shall be #2, bare soft drawn, 7 strand copper wire. Installed 12 inches below finished grade and located around the foundation used for cabinets. Drill 5/8-inch diameter holes as shown in sides of foundation if not provided by foundation manufacturer.
2. Two 5/8-inch diameter, eight foot long copperweld ground rods and approved connectors shall be installed 12 inches below finished grade.
3. Leave the ground rods and ground grid exposed until inspected and approved by the *Company* representative.
4. The ground grid is to be complete and backfilled prior to energizing the equipment.

17.0 Proper Transformer Pad and Conduit Installations

17.0-1 Proper Conduit Bank Installation (Pre-Backfill)



17.0-2 Proper Installation of Conduit with Pullbox used for Drainage (Pre-backfill)





17.0-4 Properly Completed Transformer Installation (Final Grade)



17.0-5 Properly Completed Handhole Installations (Final Grade)



18.0 Transformer Oil Containment

Figure 18.0-1 Single Phase Oil Containment for Cables in Conduit

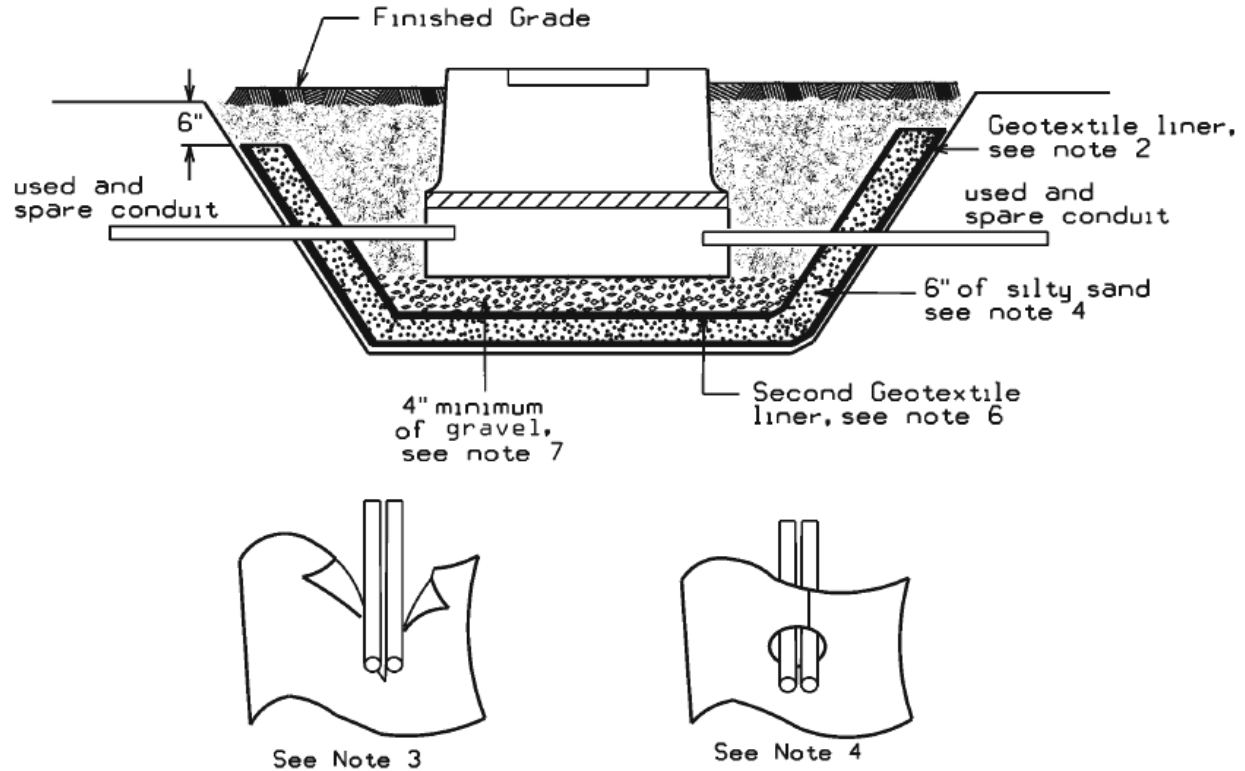

NOTES:

1. Dig out as least an additional foot on bottom and sides for boxpad area and stub conduits out into the pit.
2. Install geotextile liner in pit along the bottom and sides up to 6" from finished grade.
3. Make vertical cuts in liner to accommodate conduits.
4. Overlap the liner flaps around the conduit and seal both liner seam and in between conduits with expanding foam.
5. Fill in area with 6" of compacted silty sand.
6. Install second layer of geotextile liner by repeating steps 2 and 3.
7. Install 4" minimum of gravel base for boxpad to be at proper grade.
8. Set boxpad and make up conduits into it.
9. Install ground grid and backfill after company inspection.

Figure 19.0-2 Single Phase Oil Containment for Direct Buried Cables

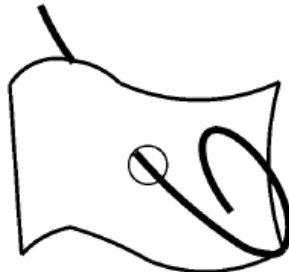
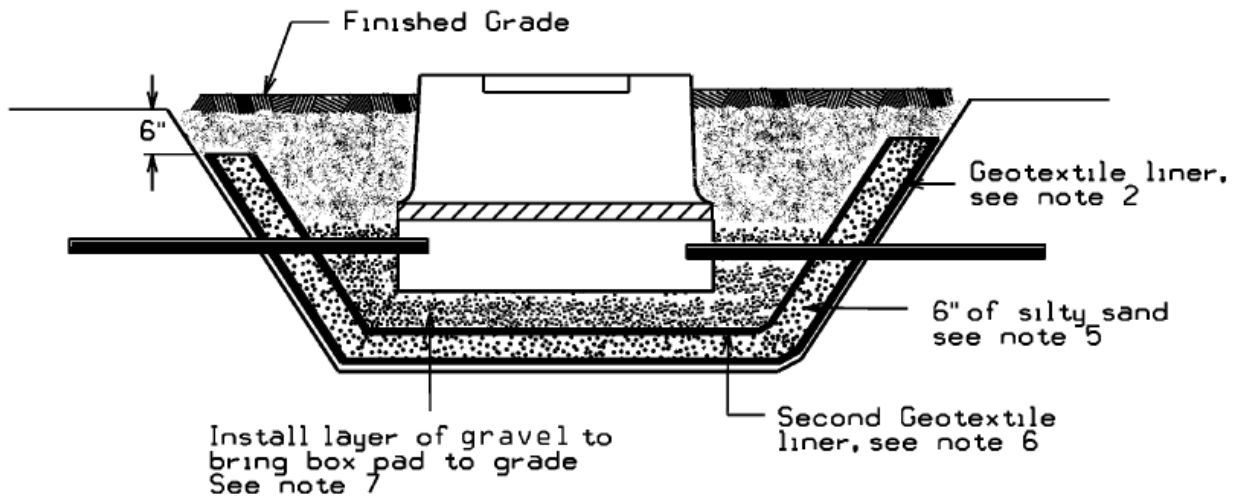

See Note 3,4

NOTES:

1. Dig out as least an additional foot on bottom and sides for boxpad area and stub conduits out into the pit.
2. Install geotextile liner in pit along the bottom and sides up to 6" from finished grade.
3. Make small holes in the liner, feed liner through holes into pit.
4. Once cable is pulled, seal the liner around the cable with expanding foam.
5. Fill in area with 6" of compacted silty sand.
6. Install second layer of geotextile liner and cut holes for cables as in note 2.
7. Install layer of gravel for cable routing and base for boxpad to be at proper grade.
8. Set boxpad, train cables into boxpad and fill on top of cables with sand.
9. Install ground grid and backfill after company inspection.

Geo-textile Liner

Geotex 401 Nonwoven Polypropylene Geotextile, 120 PSI Tensile, 140 GPM Flow, 70 Sieve, Resists UV Deterioration, rotting, biological degradation, inert to soil chemicals. Standard 15 x 360 ft. roll.

(Or equivalent)

Brand names / Suppliers are:

AME1680 available from

American Engineering Fabrics (AEF), Inc.
(Emphasize polypropylene not polyester)
New Bedford, MA

1-617-965-0007 / 1-800-770-2666 or from

Vellano Bros. Lancaster, NY

1-716-684-7222

Several other locations in New York, Massachusetts, Rhode Island and New Hampshire

www.vellano.com

Synthetic Industries ST 160 available from

Spartan Mills Inc.

Spartanburg, NC

1-803-576-2353

Carthage Mills FX-160HS

US Construction Fabrics LLC

90 Range Road

Windham, NH 03087

1-603-898-0532

19.0 Riser Pole

The *Company* shall designate conduit riser locations on the pole. All primary risers shall be Galvanized Steel, this includes the 90-degree sweep. Per NESC all steel risers must be bonded 6" from top and the bond must be at least 8' high from finished grade.

The *Customer* is responsible for providing and installing the bond clamps and the tap. The *Company* will make the bond connection from the riser bond tap to the ground system on the pole. Spare riser sweep shall be bonded also. Approved materials reference is located on Page 35 - 37.

NOTE #1 U-Guard

NOTE #2 Galvanized steel conduit and bend are to be used, they shall be grounded by bonding to an approved U-bolt type ground clamp 6" (150 mm) from top of the conduit. A 24" (600 mm) conductor shall be provided to extend to the Company's grounding conductor. The conductor shall be sized as required by the National Electrical Code, Article 250, but in no case shall it be smaller than #4 AWG copper. Recommend use of corrosion resistant bend in locations subject to highway salting.

NOTE #3 Galvanized steel conduit, galvanized steel sweep, attachment clamps, grounding clamp and 24" grounding conductor shall be furnished and installed by Customer. Normally, the conduit shall rise on the side of the pole away from traffic up to 8 ft. (2.5 m) to 11 ft. (3.4 m). Consult company for proper location on pole.

NOTE #4 Pipe straps, install at not more than 30" (750 mm) intervals.

NOTE #5 The conduit burial depth shall be 30" (750 mm) minimum.

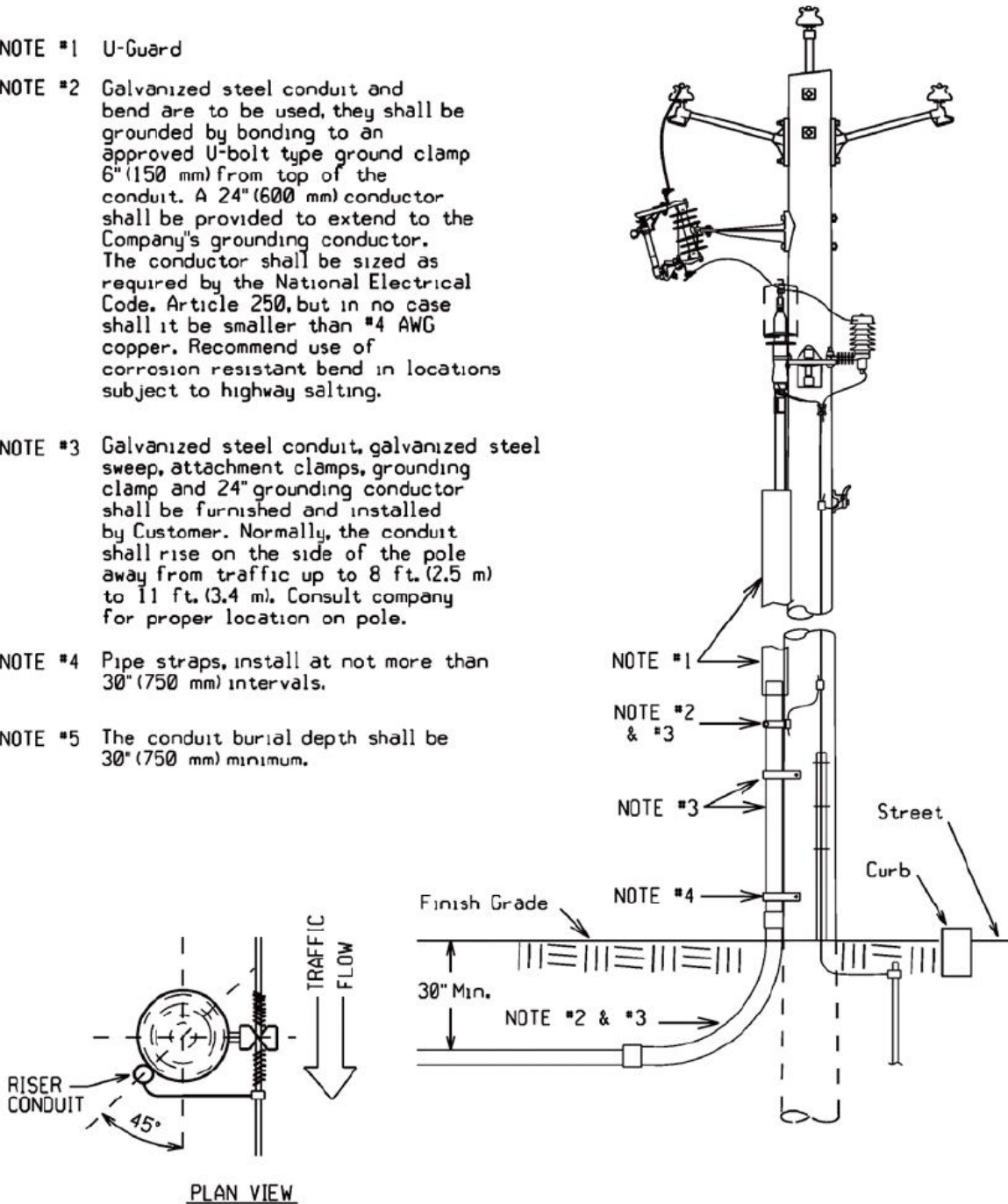

Properly Installed Primary Risers



Riser Pole Bonding
Rigid Galvanized Steel. Bond higher than 8' and at least 6" from top.

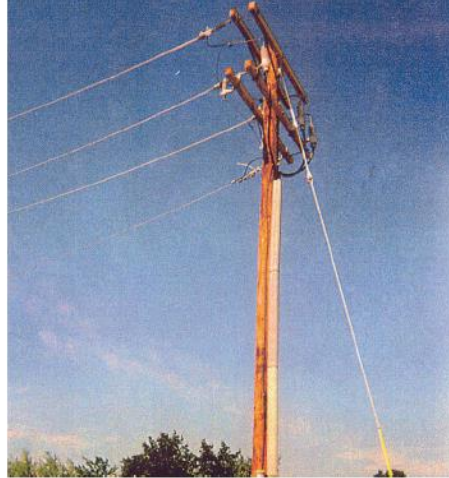

Completed Riser Pole
The Company will specify on which quarter of the pole the riser shall be installed, away from traffic.



Spare Riser Sweep
Spare sweep shall be bonded to down ground and capped at riser pole.

20.0 Primary Cable Pull/Splice Box

This primary conduit equipment may be specified in the design for installation in sidewalks or grass plot areas where duct length or design requires extra pulling locations or splices. The splice box is H20 rated and shall be installed in locations not frequently traveled over by vehicles. Pull/splice boxes are supplied and installed by the *Customer*.

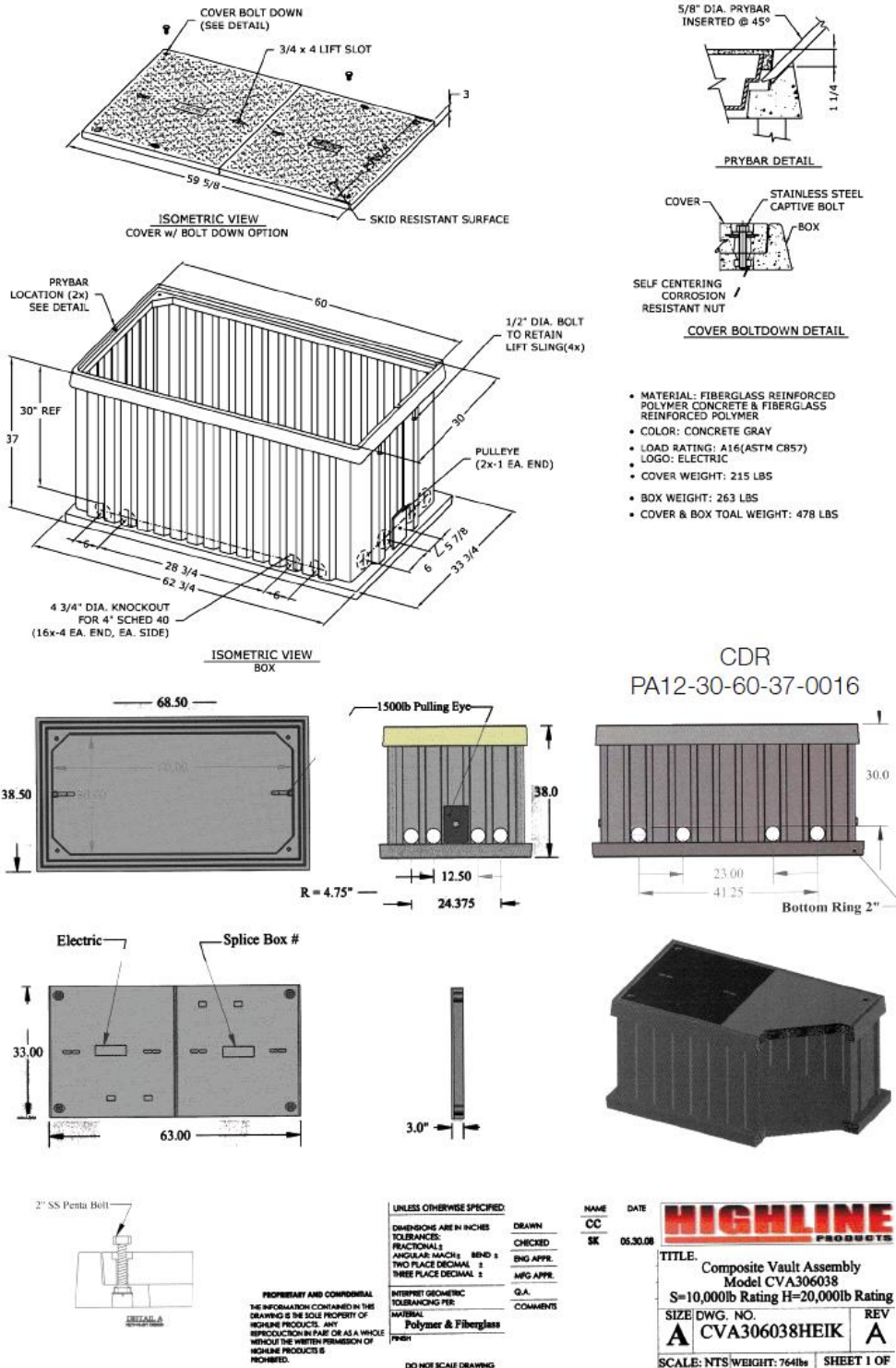

Properly Installed Primary Pullbox



21.0 Trench Requirements

Final grades shall be established; the surface rough graded within 6" of finished grade, and roadway and property boundaries shall be staked or marked by the *Customer* before any trenching is started.

The *Customer* shall adhere to the construction plan and specifications regarding trench locations, trench depth, and concrete encasement. Any deviation shall be subject to approval by the *Company*.

The *Company* shall be notified in advance of the backfilling of any electric facility. The *Company* reserves the right to require re-excavation of the conduits and foundations if the *Customer* fails to have inspection done or backfills before inspection.

If the trenching for the conduit installation is in an existing URD area that has buried energized conductors, it is an OSHA requirement to use approved electrically qualified excavators. The *Company* will install conduit/pull boxes/foundations when required to excavate around buried energized conductors at a predetermined cost to *Customer/Developer/Contractor*.

For ***special circumstances*** that call for concrete encasement, such as crossing a culvert or stream, trenches shall not be backfilled until concrete has set (for at least two hours) and after approval by authorized *Company* personnel. All backfill shall be sand or gravel containing stones less than 1" in any dimension. Backfilling shall not take place over any open-ended (unplugged) conduits. Company approved red "Warning" tape shall be installed directly above the *Company's* cable eight to 12 inches below finished grade. Laying the warning tape directly on the cable, concrete or conduit is not acceptable. Certain installations in the public way may require flowable fill instead in place of normal backfill.

21.1 Trench Depth Concrete Encased Conduit

Burial depths for electrical conduit shall be maintained not less than 30" from the top of the concrete encasement to grade during all phases of construction. The trench bottom shall be solid, undisturbed earth. Earth showing signs of peat, cinders, rubble, or any conditions not suitable for a stable foundation shall be reported to the *Company* for recommendation. Small pockets of unsuitable soil shall be replaced with compacted gravel (maximum 2" stone). At riser pole, end concrete encasement just before riser sweep.

Figure 21.0-1 Typical Trenches

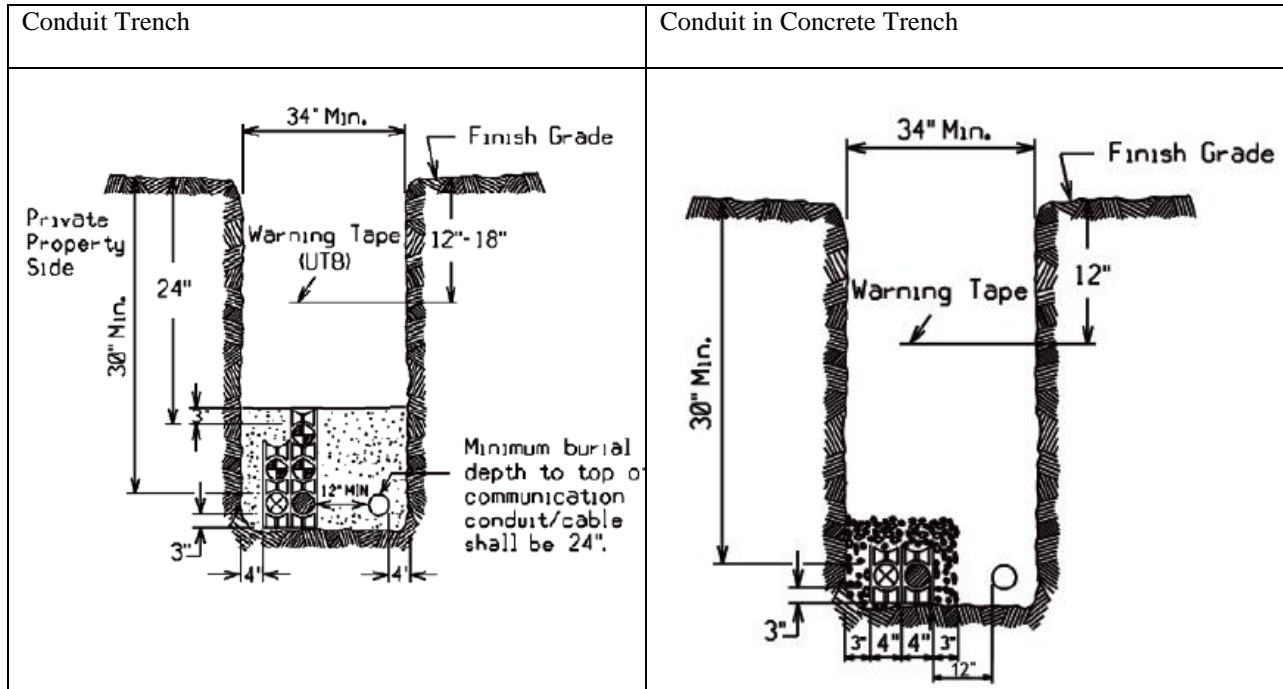

Legend

	Base Spacer		Liberty Utilities Primary Cable	
	Intermediate Spacer		Liberty Utilities Electric secondary and/or Street Light Cable	
	Secondary Electric Duct		Communication Cable	
	Primary Electric Duct		Sand or Rock-Free Sandy Loam (Clay shall not be acceptable. Site material may be reused if sand or rock free sandy loam.)	
	Communication Duct or Cable			
	Spare Duct			

22.0 Conduit Requirements

The *Customer* shall be responsible for all trenching, excavation, backfilling, and installation of the primary duct system. The *Customer* is also responsible to install any necessary pullboxes. Concrete encasement shall be provided and installed by the *Customer* as specified by the *Company* when required. Refer to 6.0 Division of Responsibility.

22.1 Pulling Tape

All conduits shall have a pulling tape, also known as “Mule Tape.” This tape is to be rated for 2,500 lbs. of tensile strength. Manufacturers of this tape are listed on Page 34.

22.2 New Hampshire:

The Customer shall ascertain the requirements of the specific municipality in which the development is located. For example, some municipalities may require that the *Customer* employ a licensed electrician to direct the installation of all conduits intended for electric facilities. Temporary mechanical protection over buried conduit and concrete cover is

recommended and/or may be required to prevent crushing or damage during construction and is the *Customer's* responsibility.

All road crossings shall, when practical, be perpendicular to the sidelines of the road.

The minimum conduit size shall be 4" for three phase and 3" for single phase cable installations. All sweeps at foundations and risers shall have a minimum radius of 36 inches. The riser sweep shall be galvanized steel. The *Customer* shall install conduit plugs in all unused conduits and pulling tape. At the riser pole, the galvanized rigid steel sweeps and the PVC/steel adaptors shall not be concrete encased. The *Customer* shall be responsible to install rigid galvanized steel straight conduit up the pole high enough to meet NESC code referenced on the riser pole requirements on Page 25, including conduit ground straps, up the riser pole (unless directed otherwise by the *Company*). The *Company* will specify on which quarter of the pole the riser shall be installed, usually away from oncoming traffic.

Except as noted on construction prints, curves and bends in conduit shall be gradual, and the radius of curvature shall not be less than 40 feet. All curves shall be formed with five-degree couplings. The minimum length between single, five-degree couplings is 42".

Conduit grade shall be such as to cause all ducts to drain toward one or both equipment foundations and pullboxes. Minimum pitch shall be three inches per 100 feet.

The *Customer* shall insure that clearances are met and maintained, and that they are inspected by the *Company*. Unless local jurisdictions require greater clearances, the minimum clearances shall be as follows:

22.3 Communication Systems – *Company* conduit shall not be directly above or below communication conduit, except when crossing below communication conduit at approximately right angles. *Company* conduit and communication conduit shall be separated by a minimum of 3" of concrete encasement.

22.4 Non-Company Water, Gas and Sewer – *Company* conduit shall not be directly above or below any of these foreign utilities, except when crossing above these utilities at approximately right angles. Where the paths of these foreign utilities cross under *Company* conduits at approximately right angles, the minimum separation is 12". A minimum separation of 24" shall be maintained between parallel placement of any of these utilities and electrical conduit.

The *Customer* shall rod and mandrel all primary conduits to ensure their integrity before the *Company* shall attempt to pull any primary cable. The *Customer* shall furnish and install an approved synthetic, 2,500-pound test tape in each primary conduit run including risers. Pulling tape installation and rodding the duct shall be witnessed by the *Company*.

Company-owned duct shall not share a concrete encasement with foreign utilities (e.g., do not place communication or private electrical duct in the same concrete encasement as Company duct).

At those locations where manholes or above ground switchgear are required, additional specifications will be provided by the *Company*.

23.0 Metering

Refer to the *Company's* Specification for Electrical Installations book for the type of installation. Division of work and material will be performed with the approval and authorization of the *Company's* Metering Services department. In general, the *Company* will own and install meters for all electric service installation at *Company* designated and approved locations.

24.0 Sectionalizing Cabinets – Three - Phase and Single-Phase Applications

This primary sectionalizing cabinet may be specified in the design for installation in the UCD or URD primary distribution system. The *Company* will supply and install this equipment. The foundations used for mounting this equipment will be part of the duct system infrastructure which is the responsibility of the *Customer/Developer*. The three-phase sectionalizing cabinet is designed to fit on top of a primary cable pull/splice box and a single phase sectionalizing cabinet is designed to fit on top of a transformer box pad foundation. Both sectionalizing cabinets require the installation of a ground grid (installed by *Customer/Developer*), see detail below.

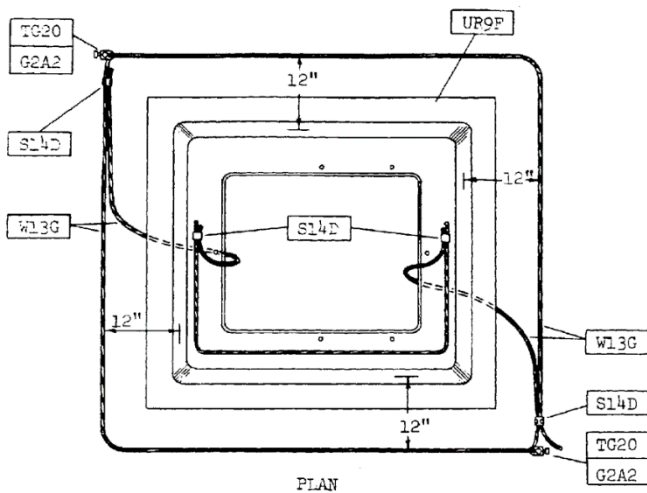

STREET SIDE AND POSITION OF FRONT OF PAD MOUNTED ENCLOSURE

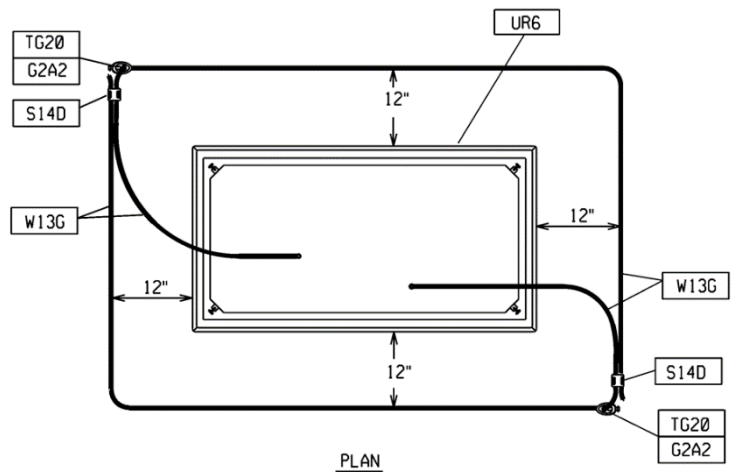

1. The ground grid shall be #2, bare soft drawn, 7 strand copper wire. Installed 12 inches below finished grade and located around the foundation used for cabinets. Drill 5/8-inch diameter holes as shown in sides of foundation if not provided by foundation manufacturer.
2. Two 5/8-inch diameter, eight-foot long copperweld ground rods and approved connectors shall be installed 12 inches below finished grade.
3. Leave the ground rods and ground grid exposed until inspected and approved by the *Company* representative.
4. The ground grid is to be complete and backfilled prior to energizing the equipment.

25.0 Easement Applications Form

LIBERTY UTILITIES EASEMENT APPLICATION FORM

FOR LIBERTY UTILITIES' USE ONLY			
Application for Easements (check one):	<input type="checkbox"/> OH (jointly owned or solely owned)	<input type="checkbox"/> UG	<input type="checkbox"/> Electric
	<input type="checkbox"/> Padmount transformer only	<input type="checkbox"/> URD	<input type="checkbox"/> Gas
Work Request Number _____			
Utility Engineer's Name: _____ Telephone Number: _____			

Please complete **ALL** of the sections below so that we may prepare an easement for your signature. Do not leave any sections unanswered. If a section does not apply to you simply put "n/a" on that line. Incorrect or incomplete information will delay service installation.

Property Owner(s): _____

Property Owner Mailing Address

Property Address of Easement
(if different from mailing address)

Address: _____
 City: _____
 State & County _____
 Zip _____

Address: _____
 City: _____
 State & County _____
 Zip _____

Customer Contact Person: _____

Daytime Phone(s): _____

Re: Subdivision Title: _____

1. Provide us with a **RECORDED** copy of the present owner's deed, Book _____ Page _____
 - a) If multiple deeds make up the whole parcel, please include all deeds.
 - b) If the Property Owner is a b1) CORPORATION, b2) TRUST, b3) PARTNERSHIP, or b4) LIMITED LIABILITY COMPANY, provide the following which is applicable:

b1) President Name: _____ Treasurer Name: _____
See Footnote 1 Below

Or

Vice President: _____ Asst. Treasurer: _____

1 If neither "Name Combinations" is available, the person(s) signing the easement must have a Corporate vote authorizing them to sign on behalf of the Corporation.

b2) Trust: No. Of Trustees: _____ Name(s): _____

Name of Trust: _____

b3) Partnership: Number of Partners: _____ Name(s): _____

b4) LLC: Authorization to Sign, Name(s): _____

2. a) Provide us with an approved: “Definitive Subdivision Plan”

Plan Book: _____ Plan: _____ Dated: _____

b) If there is no recorded subdivision plan please include the following information:

Assessor’s Map: _____ Block: _____ and Lot: _____

3. Is your property mortgaged (circle one)? YES NO

If “YES”, please complete this section:

a) Name of Bank/Company/Person holding mortgage(s): _____

b) Address of mortgage holder(s): _____

c) Date and recording information of mortgage(s): _____

Date: _____ County Recorded: _____ Book: _____ Page: _____

Additional Comments:

Please contact your Account Manager or Service Administrator if you have any questions regarding this form.

26.0 Approved Material – Underground Residential Development (URD) Installations

Liberty Item ID	Item Description	Manufacturer 1 Part Number	Manufacturer 2 Part Number	Manufacturer 3 Part Number
-----------------	------------------	-------------------------------	-------------------------------	-------------------------------

Conduit – Straight

8830-2010404	Conduit DB, 4", PVC	Carlton: 48815	IPEX: 8741	Cantex: A79EA42
8830-2011024	Conduit, Galvanized, 4"	By Description		
8830-5692158	Conduit DB, 3", PVC	Carlton: 48815	IPEX: 8731	AMERICAN PIPE TC7215752
8830-5692107	Conduit, Galvanized, 3"	BAYNEJONES 300R		

Conduit—Blends

8830-5690446	Bend, Galvanized, 4" 36"	BaynesJones 400R9036	Conditmfg TUB490D36RGA LEL	
8830-5690493	Bend, PVC Sch 40, 4", 90 Degree, 36" Rad.	Carlton: UA9FNB	Cantex: 5233842	
8830-5690436	Bend, Galvanized, 3" 36"	BaynesJones 400R9036	Conditmfg TUB490D36RGA LEL	
8830-5690419	Bend, PVC DB, 3", 90 Degree, 36" Rad.	Carlton: PF9FL	Cantex: 5123872	Certisaft 59734

Spacers

8830-5646963	Spacer, 4", Base	GS Industries: 186-1	IPEX: 29573	
8830-5646960	Spacer, 4", Inter.	GS Industries: 185-1	IPEX: 29557	
8830-5646958	Spacer, 3", Base	GS Industries: 157-1	IPEX: 29569	
8830-5646956	Spacer, 3", Inter.	GS Industries: 156-1	IPEX: 29553	

Liberty Utilities Item ID	Item Description	Manufacturer 1 Part Number	Manufacturer 2 Part Number	Manufacturer 3 Part Number
---------------------------	------------------	----------------------------	----------------------------	----------------------------

Conduit Accessories

8830-5641210	Riser Strap, 4"	Electrical Materials: 50-4 USHD	BaynesJones MINRLAC HD-296	
8830-5641205	Riser Strap, 3"	Electrical Materials: 50-3 USHD	BaynesJones MINRLAC HD-294	
8830-7011830	Lag Screw, 1/4" x 2"	Elect. Materials: 106 or 106M	Joslyn J26486.1	PLH LSNW-142
8830-3503074	Pipe Grd. Connector, 4" and 5"	T & B: (O)3905-BU	Burndy GAR3905-BU	
8830-3503075	Pipe Grd. Connector, 2.5" and 3.5"	T & B: (O)3904-BU	Burndy: GAR3904-BU BGAR3905-BU	
8830-2010424	Duct Plug, 4" DB	Carlton: P258NT		
8830-5645682	Duct Plug, 3" DB	CSNTEX: 5315260	CARLON: P258L	CERTIFSAFT: 59653
8830-2011254	Duct Plug Galvanized 4"	Crousehinds PLG105		
8830-9201659	Duct Plug Galvanized 3"			
8830-2010434	Adapter, Female, PVC-Steel, 4"	Carlton: E942N	Cantex: 5140052	Scepter FA55
8830-2010433	Adapter, Female, PVC-Steel, 3"	Carlton: E942N	OZGEDNEY: PLG- 300C	
8830-5693359	Coupling, 5 Degree, Bell-Spigot, 4"	Carlton: E244N	Cantex: 6151452	Certisaft 59544
8830-5693356	Coupling, 5 Degree, Bell-Spigot, 3"	Cantex: 6151450	Carlton: E244L	
8830-2010444	Coupling, 5 Degree, Bell-Bell, 4"	Ameripipe: FT518	Carlton E2440NF	Scepter 7604360040
8830-5100696	Coupling, 5 Degree, Bell-Bell, 3"0	Ameripipe: NS141	Carlton: 6151458	
8830-2010454	Straight Coupling, 4", EB/DB	Carlton: E240N	Cantex: 6151450	
8830-2010453	Straight Coupling, 3", EB/DB	Cantex: 6151450	Carlton: E2544L	

Liberty Utilities Item ID	Item Description	Manufacturer 1 Part Number	Manufacturer 2 Part Number	Manufacturer 3 Part Number
---------------------------	------------------	----------------------------	----------------------------	----------------------------

Grounding Accessories

8830-5961285	Grounding Bushing, 4" and 5"	Burndy GAR3905-BU	T&B: (0)3905-BU	
8830-3500313	Grounding Rod 5/8' x 8' Solid Copperweld	Galvin 6258	ERITECH 615880	Joslyn: J8338
8830-4015032	#2 AWG, 7 strand, soft drawn	South Wire - By description		
8830-3503328	Ground Rod Clamp	Burndy: GRC58	Blackburn: JAB58H	Electromotion EM58DBW
8830-5960412	"C" Connector, 2/0 – 2/0	Burndy: YC26C26TN		

**Primary Pull/Splice box, Secondary Handholes and transformer foundations
Wesco or Graybar – Manchester, NH**

8830-5640808	Primary Pull/Splice Box	Highline: CVA306038HEIK		Quazite (Hubbell): PA12-3060-37-0271
8830-5643082	Secondary Handhole	Highline: CHA173030SE1-NG		Quazite (Hubbell): PA10-1730-30-0319
8830-5642500	Transformer Foundation	Highline: PBP374342NEPS		Quazite (Hubbell): BP10-3843-42-0096

Other Materials

Condux: 08096303	Secondary Connections	Bundy	Richards	
	MULETAPE	Arnco: DLWP25	NEPTCO# WP2500P	Condux: 08096303

Precast Concrete Street Lighting Foundation
 8-1/2" Bolt Circle – URD Post Top Luminaire Installations
 Liberty Material Specification – LU6640
 Liberty Item ID 8830-9201524 SAP # **5379**
Purchase from: Shea Concrete Products
160 Old Concord Turnpike, Nottingham, NH – 1-603-942-5668

27.0 Job Checklists

URD CONDUIT INSPECTION CHECKLIST

Do not back fill BEFORE conduit system inspection and approval by the Company have been obtained. Every item below must be inspected and checked off by the Company representative. Any item found unacceptable must be initialed and rectified by Customer by next inspection.

N* Y*

PRE-TRENCH

- Final Grade established
- Surface rough graded
- Roadways staked

TRENCH

- Minimum 30" depth from finishing grade to top of primary conduit
- Minimum 24" depth from finishing grade to top of secondary conduit
- Minimum 12" separation between Electric conduits and Telecommunications conduits
- Min, 24" separation between Electric conduits and water, sewer or gas if placing parallel
- Minimum 12" separation between Electric conduits and water, sewer or gas if placing perpendicular
- Conduit plugs installed
- Plastic spacers properly installed no more than every 8' and at every junction point
- 4" screened backfill (with less than 1" stones) on-site for backfilling entire trench, (inspector may witness backfilling)
- Warning tape installed 12" below finish grade and directly above electrical conduit system
- All curves properly formed with five degree couplings
- No parallel utilities directly above electrical system

Secondary Handhole

- 4" crushed stone under handhole
- Handhole covers installed and properly secured with pentahead bolts
- Top surface flush with final grade
- Conduit plugs installed from the outside in all unused conduit knockouts
- No more than 3" of extended PVC into handhole

Transformer Foundation

- 4" of crushed stone under transformer foundation
- Top surface 4" above final grade
- No more than 3" extended PVC through foundation
- Pulling eyes properly installed in front and back of box pad (ring part on the inside)
- Conduit plugs installed from the outside in all unused conduit knockouts
- Two ground rods installed at opposite corners of foundation – exposed for inspection
- Ground grid buried 12" below finish grade and placed 12" away from edge of boxpad
- Loop ground grid around and into foundation through two sides of foundation
- Correct orientation to road and lot lines
- All non-Company owned pedestals are a minimum of 2' away from all sides

Pullbox

- 4" or crushed stone under pullbox foundation
- Pullbox covers installed and properly secured with pentahead bolts
- Top surface flush with final grade
- No more than 3" extended PVC into pullbox
- Conduit plugs installed from the outside in all unused conduit knockouts
- All non-Company owned pedestals are a minimum of 2' away from all sides

RISER POLE

- 90° bend and 10' straight riser pipe galvanized steel conduit. (3" for single Phase, 4" for three phase)
- Steel-PVC adapter and steel sweep shall not be encased in concrete
- Ground clamp installed with tap
- Install 2500 lb. Pulling Tape in all conduit after rodding with mandrel

**NOTE Y – Acceptable N – Deficient*

28.0 Revision History

Date	Rev #	Description	Author/Lead Person
07/03/12	0	Initial Version of Document	Robert J Johnson
04/01/14	1.0	Update to reflect new Liberty Utilities Policy 2 Line Extension Policy for Residential Developments (URD)	Robert J Johnson
10/01/18	2.0	Update to reflect new Liberty Utilities Policies for new Electric Tariff requirements for underground service	Robert J Johnson
1/1/2024	3.0	Updated to reflect Customer will be responsible for providing transformer boxpad foundation w/grounding & URD St lighting foundation to Liberty Specification	Robert J Johnson



Liberty is committed to providing safe, reliable, and cost-effective rate-regulated electric, natural gas and wastewater treatment utility systems and electricity generation, transmission and distribution utility services to over 1 million customer connections, largely in North America.

Liberty is unique among its peers for its commitment to the community, conservation, and customer service. Liberty upholds the highest standards of service to meet the day-to-day needs of its customers and offers employee programs that recognize superior customer support and contribution to the community.

Liberty

15 Buttrick Rd
Londonderry, NH 03053
1-800-375-7413

www.libertyutilities.com